

Operation Manual

-- Ricoh Roll To Roll UV Printer

Introduction

Thanks for purchasing Refretonic Ricoh Roll to Roll UV Printer. To ensure correct and safe use on the basis of a thorough understanding of the performance of this product, please read this manual carefully and keep it properly.

The operation manual and printing program only can be used by Refretonic authorized legal holders. The legal holders are strictly forbidden to copy, modify, exchange or distribute all the contents to the outside world through the Internet and all other means without the formal authorization of the right holder. Anyone who violates the above actions shall be liable for criminal liability and civil liability.

If there are any changes of the contents of the manual and the product parameters, you won't be notified.

Refretonic is not responsible for any technical or editorial errors and omissions in this document.

We have tried to edit this manual and check this product. If there are any errors, please tell us, and we will be very grateful.

Trademark statement:

All trademarks, manufacturers, and product names cited in this book are listed below:

Windows 98, Windows ME, Windows2003, Windows2000, Windows VISTA, Windows 7 are registered trademarks of Microsoft Corporation.

Photoshop is the trademark of Adobe Corporation.

PhotoPrint is the trademark of Photoprint Corporation of America.

Epson is the trademark of Epson Corporation of Japan.

Content

1. Security Guidance	1
2. Installation Requirements	5
2.1 Recommend computer hardware and software configuration.....	5
2.2 Site preparation.....	5
2.2.1 Work area.....	6
2.2.2 Environmental requirements.....	6
2.2.3 Floor requirements.....	7
2.2.4 Load-bearing requirements.....	7
2.2.5 Space reservation requirements.....	7
2.2.6 Safety requirements.....	7
2.2.7 Electrical requirements.....	8
2.2.8 Operator requirements.....	9
2.2.9 Installation regulations.....	9
2.3 Pre-installation check.....	10
2.4 Shipment, unpacking and checking.....	10
2.4.1 Shipment.....	10
2.4.2 Unpacking.....	11
2.4.3 Checking.....	11
3. Identify the Body Part and the Random Accessory	11
3.1 The body part identification chart.....	11
4. The Installation of the Machine	12
4.1 Fix foot cup and machine.....	12
4.2 Install taking up / feeding up system.....	13
4.3 Install ink tank.....	13
4.4 Install ground wires.....	14
5. How to Use	15
5.1 How to use—basic.....	15
5.1.1 How to connect a USB cable.....	15
5.1.2 How to turn on the power cable.....	16
5.1.3 How to add ink.....	17
5.1.4 How to install media.....	18

5.1.5	The available media.....	20
5.1.6	How to use induced draft of the platform.....	22
5.2	How to use—printing.....	22
5.2.1	How to feed / take and set the print start position.....	22
5.2.2	How to print the heads status test strip to check the print head.....	23
5.2.3	How to press ink.....	25
5.2.4	How to adjust the height of the carriage.....	26
5.2.5	How to start, pause and stop.....	26
5.2.6	The distinction between print modes.....	28
5.2.7	How to take up the picture.....	30
5.2.8	How to maintain the print head.....	31
5.3	How to use-- LCD control panel.....	32
5.3.1	The layout of the control panel.....	32
5.3.2	Instructions for the use of the buttons.....	32
6.	Instructions for Using the Software.....	35
6.1	The installation of the software.....	35
6.2	Interface description.....	38
6.2.1	Toolbar.....	38
6.2.2	Quick exit button.....	41
6.2.3	Print parameter real-time settings bar.....	41
6.2.4	Print job information bar.....	42
6.2.5	Print job.....	42
6.3	Parameter setting.....	44
6.3.1	Print setting.....	44
6.3.2	Personality setting.....	44
6.3.3	Offset correction.....	45
6.4	Print head calibration.....	45
6.4.1	Check the dislocation of the hole.....	46
6.4.2	Check the incline.....	47
6.4.3	Check the vertical spacing of the print head.....	48
6.4.4	Check the stepping.....	49
6.4.5	Two-way adjustment.....	51
7.	Check the Defect (Blockage) of the Print Head.....	55

8. Refretonic Customer Service.....	57
--	-----------

1. Security Guidance

Safety precautions:

Before you connect the printer to the power supply, please read the following safety precautions to ensure safe use of the device.

General safety criterion:

- ◆ Please refer to the installation instructions before you turn on the printer.
- ◆ Turn off the printer when any of the following conditions occur. And remove the plug, and then call the local distributor.
 - The power cord or plug is damaged.
 - Liquid flows into the printer.
 - The printer is dropped, or the drying is damaged.
 - The printer smokes or sends an unusual smell.
 - The built-in earth leakage circuit breaker of the printer is tripped repeatedly.
 - A fuse has blown.
 - The printer is not working properly.
- ◆ Turn off the printer when any of the following conditions occur.
 - Thunderstorms.
 - The power is interrupted during printing.

Important safety criterion:

- ◆ Do not insert anything into the printer's platform, and be careful not to spill liquid into the printer.
- ◆ You can only use the type of power identified in the printer's label. According to the different countries and regions, you may choose 110V or 220V AC power.
- ◆ Connect all devices to an appropriate ground socket to avoid switching device in the same circuit.
- ◆ Avoid using sockets controlled by wall switches or automatic timers.
- ◆ Keep the computer system away from potential sources of electromagnetic interference. For example, loudspeaker or cordless telephone stand.
- ◆ Do not use damaged or worn power cord.
- ◆ If you are using an additional power cord, make sure that the total ampere of the

additional power cord should not exceed the rated amperage of the power supply. What's more, remember that the total amperage of all devices inserted into the wall should not exceed the rated amperage of the wall outlet.

Announcements when using the printer:

- ◆ When the printer turns on, you can't move the printer head. Otherwise, the printer will be damaged.
- ◆ You should use the power switch to turn off printing, when you press the button, the power will be cut off. You can't unplug the printer plug or data cable until the power is cut off.
- ◆ Before moving the printer, you should make sure that the print head is in the initial position and then make it fixed.

Shock hazard



Warning: The drying system uses normal alternating current. When using the system, you can't extend your hand or other objects into the drying system; otherwise it will do harm to your body or damage the object.

- There are two power cords in the printer. Please unplug the two power cords before repairing the printer. The printer can only be connected to a grounded AC outlet.

To avoid the risk of electric shock, please note the following:

- Do not attempt to remove the drying or electrical control cabinet.
- Do not remove or open any other closed system cover or plug
- Do not insert any objects into the printer's slot.



Attention: Fuse blown may indicate that the circuit in the system has failed. Please call the local distributors instead of replacing the fuse by yourself.

The risk of scalding

The printer's drying system operates at high temperatures, if you touch it, which may cause burns. To avoid personal injury, please pay attention to the following precautions:

- Do not touch the internal cover of the printer's drying system. Even after disconnecting the power of the drying system, the internal surface may still be hot.
- You should be particularly careful when contacting the material drying channel.

Fire

The printer's drying system will produce high temperatures during its operation. If the printer's built-in earth leakage circuit breaker is repeatedly tripped, please call your local distributors.

To avoid the risk of fire, please note the following:

- Please use the power supply voltage specified on the nameplate.
- Connect the power cord to a dedicated line, and according to rated parameters of the wall socket, you can use branch circuit breaker to protect each line. Do not use a terminal block (plug) to connect two power cords.
- Use Refretonic power cord for the printer. Do not use damaged power cords. Please don't use the power cord with other products.
- Do not insert any objects into the printer's slot.
- Be careful. Do not spill liquid on the printer.
- Do not use sprays containing flammable gases inside or near the printer.
- Do not block or keep out the printer's opening.
- Do not attempt to remove the drying system or electrical control cabinet.
- Load the material (medium) that can be used at operating temperatures of 125 ° C (257 ° F) and with an autoignition temperature above 250 ° C (482 ° F).

Mechanical hazard

The moving parts of the printer may cause personal injury. To avoid personal injury, when you work close to the printer please pay attention to the following precautions:

- Keep all parts of the clothing and body away from the moving parts of the printer.
- Do not wear necklaces, bracelets and other hanging items.
- If your hair is long, protect it carefully. Otherwise, it will fall into the printer.
- Do not let the sleeves or gloves to be entangled by the moving parts of the printer.
- Do not touch the gear or move the roll during printing.

The risk of overweight material (medium)

When dealing with heavier substrates, you should be especially careful to avoid personal injury.

- There may be a need for more people to carry heavier substrate rolls. You should be careful to avoid back injury.
- Please consider using a forklift, pallet truck or other handling equipment.
- When handling heavier substrate rolls, you should wear personal protective equipment, including work boots and gloves.

Ink treatment

- Put the ink bottles away from the child's reach. Do not let the children drink or contact ink bottles.
- If the ink sticks to the skin, rinse with soap and water. If the ink splashes into the eyes, rinse immediately with water.
- Do not shake the ink bottle, which will cause the ink leak.
- After the ink bottle has been used for a period of time (usually three months), you should remove it immediately for thorough cleaning and dry. When replacing the new ink bottle, pay attention to cleaning to ensure the print quality.
- As for the disposal of waste ink, please follow the relevant local laws.

Warning and attention

This manual uses the following symbols to ensure proper use of the printer and to prevent damage to the printer. Please follow the instructions marked with these symbols.



Warning Failure to follow the guidelines marked with this symbol may result in serious personal injury or even death.



Warning Failure to follow the guidelines for this symbol may damage the printer.



Attention Failure to follow the guidelines marked with this symbol may result in minor personal injury.

2. Installation Requirements

2.1 Recommend computer hardware and software configuration

- ✧ CPU: Intel Core Duo 3.5GHZ and above
- ✧ Memory: 4GB and above
- ✧ Hard disk: 1TB (preferably with SSD)
- ✧ Mainboard: INTEL G41 and above
- ✧ Operating system: WINDOWS 7/8/10 and above Microsoft operating system

2.2 Site preparation

- ✧ Customers are responsible for following all installation requirements and performing them during the operation of the machine.
- ✧ If not, the machine may not run properly.

2.2.1 Work area

The work area listed below is the area close to the Refretonic Hybrid UV Printer (hereinafter referred to as the device). We should emphasize that the user should ensure the safety of the operator in this area. The work area is 6 meters long, 6 meters wide and 2.5 meters high. Refretonic Hybrid UV Printer (2.1 meters wide) size: 4.1 meters long, 1.2 meters wide, and 1.5 meters high.

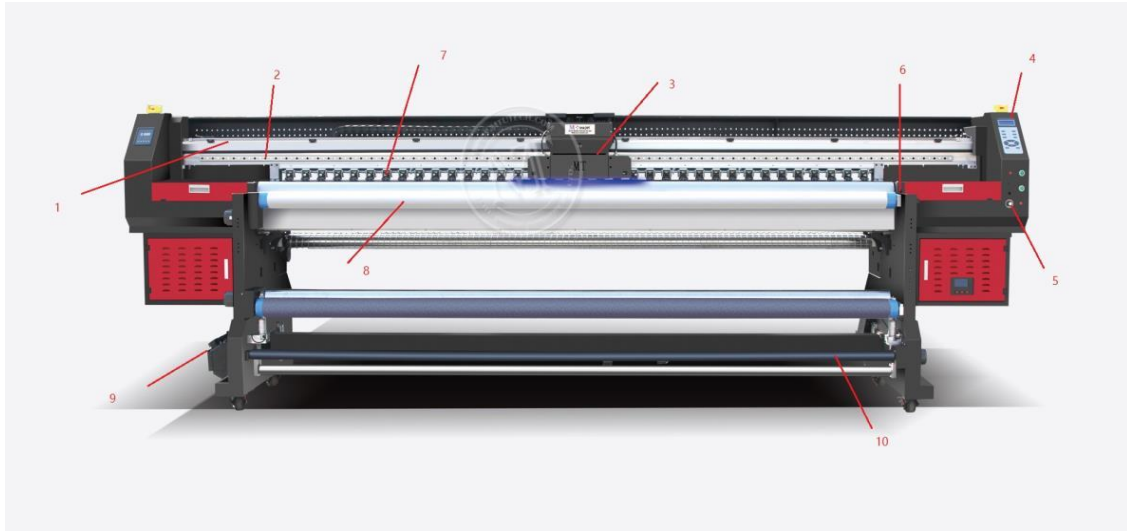

2.2.2 Environmental requirements

The equipment should be away from the seam device (fabric feeder) or other radio frequency interference sources. The floor should be easy to clean and not produce dust and static electricity. In order to help the operator and the customer determine the accuracy of the color, neutral gray decoration and pure white (fluorescent) lighting should be used.

The equipment should be installed in an environment that is clean, dust free, temperature and relative humidity controlled in the following range:

Altitude: 1000 meters below

Temperature: 15-35 ° C

Relative humidity: 40%-65%

2.2.3 Floor requirements

The ground material in the work area should be able to ensure safe and uniform

dispersion of the weight of the system. During the installation, the system should maintain a precise level, to ensure the correct level of movement of the printer head, to prevent sliding and bending.



Warning The floor material in the work area must be able to prevent static electricity and prevent dust from accumulating. If necessary, you can lay clean tiles in the work area or polish the concrete floor before the device is in place. Do not use floor materials such as carpets.

2.2.4 Load-bearing requirements

- ✧ The net weight of the equipment is 500-700kg.
- ✧ The largest roll material generally increased by 60 kg.
- ✧ It is recommended to install the equipment on 4 steel plates of 20 cm in diameter, or 4 sheets of 200 x 200 mm or more of 8 mm above the thickness of the steel plate.

2.2.5 Space reservation requirements

The front of the equipment is the inkjet input side. The front of the equipment is reserved for 2 meters. The back retains 2 meters, left and right sides retain 1 meter. In addition, the space-reserved area includes 2.5 meters above the ground height. The front and rear of the machine should allow space for loading and unloading the screen and supplies.

2.2.6 Safety requirements

- ◆ Fire protection
 - ✧ The ink and solvent must be packed in non-combustible liquid storage tanks or independent storage rooms. And they must be clearly identified to meet the requirements of the professional safety regulations.
 - ✧ Ink storage must strictly comply with local regulations on the use and storage of combustibles.
 - ✧ Carbon dioxide and dry powder fire extinguishers should be placed in all accessible channels. They should be placed near the equipment and

non-flammable liquid storage cabinets, or comply with local fire safety regulations.

◆ Ventilation

To prevent the danger of accumulated volatile gases, there must be adequate ventilation to ensure the replacement of the air about 6 to 8 times every 1hour. The vents should be low enough so that the volatiles can't be accumulated near the floor.

When the fabric passes through the dryer, the solvent in the ink will evaporate, so an exhaust system is needed to drain it.



Attention:

The proportion of solvent gas is greater than air, and it will be accumulated near the floor.

Electrical equipment installed near the work area must comply with the GB / T standard.



Attention Hazardous waste treatment shall comply with the requirements of specific special storage and handling of the relevant departments.

2.2.7 Electrical requirements

The equipment uses a single-phase power supply and requires a guaranteed independent grounding. Grounding resistance is less than 10 ohms.

The supply voltage range is 220V (± 10%), AC 50Hz or 60Hz. The power line output must be installed by the professional electrical personnel or contractors.

The following is the circuit breaker rating.

Voltage	AC 220V	AC 110V
---------	---------	---------

Simplex	20A / phase	40A/phase
---------	-------------	-----------

The maximum power consumption is less than 7 kilowatts; the average power consumption is 2.4 kilowatts. UPS can use 8KW, and can access the computer and the power of the machine.

2.2.8 Operator requirements

- ◆ For the operator of the equipment, the following requirements and responsibilities are recommended.
 - ✧ Responsible for operation and maintenance of equipment
 - ✧ Contact with Refretonic after-sale technical department
 - ✧ Solve problems and maintain by telephone
 - ✧ Experienced in Windows and PC
 - ✧ Technical background in electronics and machinery
 - ✧ The ability and theory of color, the knowledge of printing front end and post-production

2.2.9 Installation regulations

- ◆ The equipment must be installed in a level place. After the equipment is in place, put down the foot cup. Adjust the equipment based on the level.
- ◆ It is advisable to install a phone near the operator console for easy maintenance and day-to-day communication.



Warning Be sure to connect the ground wire before the equipment is powered on. The ground resistance and zero resistance must be less than 10 ohms.

2.3 Pre-installation check

- ✧ The voltage of the site should be reported to the distributor in advance.
- ✧ The power input jack is at the left end of the equipment.

- ✧ The air conditioning in the room should be 15 - 35 ° C.
- ✧ Customers cannot open the box without technician.
- ✧ Any damage to the box shall be taken before the technician arrives and immediately report to the distributor.
- ✧ The customer must complete all the preparatory work and cleaning work before the technician arrives because the dust may cause some damage to the machine.
- ✧ The customer should be ready for other required device, such as Apple computers and Photoshop, Freehand, Illustrator and other application software and 100M-computer network.
- ✧ During installation, there should be at least two operators with skilled computer skills. It is much better that they have experience in inkjet.
- ✧ Customers shouldn't product alone when their operators don't have enough experience. They should be trained in advance.
- ✧ The ink takes longer from order to delivery. In order not to affect the production, the customer should make a reservation.
- ✧ To minimize downtime, the factory should provide some spare parts to customers to buy.

- ✧ The loading box is marked with "left and right" and "front and back" respectively. Please pay attention when loading and unloading.
- ✧ Please carefully read the technician's installation check file, the table should be marked with "yes". After the site is ready, give the table back to the customer service department maintenance center before installing.

2.4 Shipment, unpacking and checking

2.4.1 Shipment

- ✧ Pay attention to the signs on the surface of the wooden box. Handle with care. Don't superimpose heavy objects on it. And pay attention to the rain.
- ✧ Vehicles must be smooth when transporting. No emergency brake and sharp turns.

2.4.2 Unpacking

- ✧ If there is damage when unpacking, take photos in time and solve the problem, and then report to Refretonic.

- ✧ Remove the top cover of the box.
- ✧ Remove the surrounding wood after removing the large bolts around the box.
- ✧ Move the machine out and inspect the random items.

2.4.3 Checking

- ✧ Check the items one by one with the technician.
- ✧ After checking, the customer signs the list and the technician will bring it back. If there is any omission, Refretonic will make up for it immediately.

3. Identify the Body Part and the Random Accessory

3.1 The body part identification chart

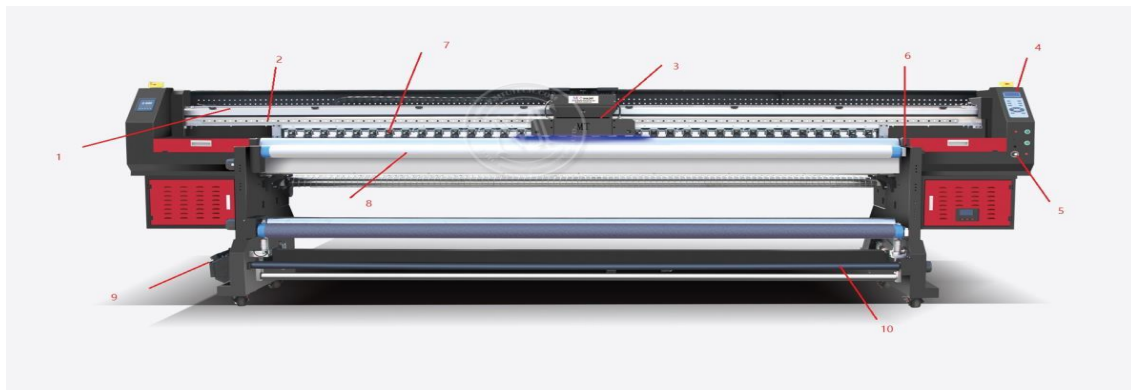

1. Grating	2. Guide	3. Carriage
4. LCD control panel	5. Suction control button	6. Pressing cloth wheel wrench
7. Pressing cloth wheel	8. Front Tension	9. Ink bottle
10. Receiving System	11. Back Tension	12. Discharge system

4. The Installation of the Machine

4.1 Fix foot cup and machine

Place the machine on a level floor and lock the wheels.



4.2 Install taking up / feeding up system

Install paper receiver

(1)

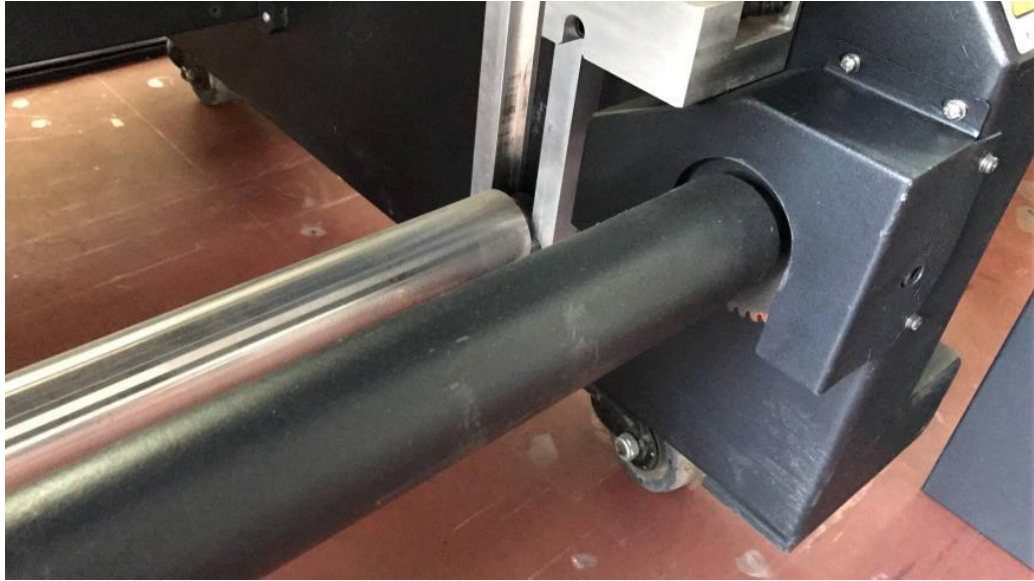

4.3 Install ink tank



Attention: Please close the valve, when the equipment is not used or replaced for a long time.

4.4 Install ground wires

1) Bury the iron bar

Bury 1m-1.5m round steel (diameter 1cm-2cm) or angle steel in the moist soil.

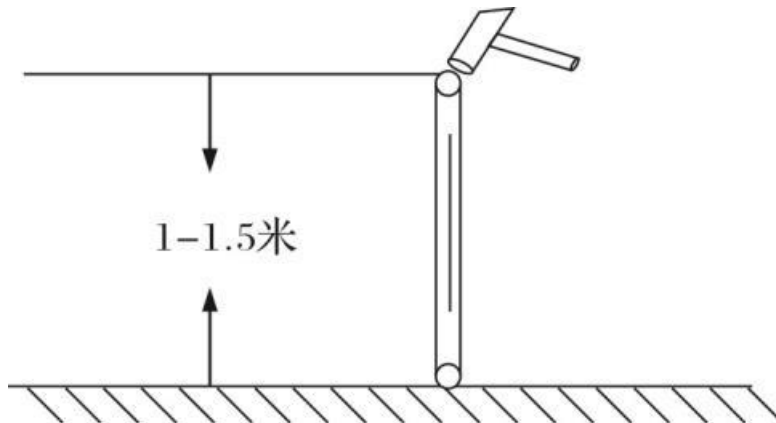

Attention Please confirm whether there is a transformer or other national power / communication cable or facility near the iron bar buried. Buried iron bars should stay away from these facilities.

2) Salt watering

Mix 500g salts with 1000g water and then water it on the iron bar.



Attention

- ✧ Salt must be completely dissolved in water.
- ✧ To guarantee the conductivity of the ground wires, please water once a month.

3) Wiring

Weld a two-meter-long wire to the iron bar. The other end is attached to the screw at the mark of ground wires. If there are no such signs, connect it to the exposed parts of the machine shell (somewhere unpainted, such as casters and the ground wires on the public wiring board)

4) Measure the resistance to ground

In the case of machine power, measure the phase line and zero line of the machine with the electric pen (Please refer to the relevant literature.) And then turn off the machine, the multimeter hit the minimum resistance, measuring the resistance between the ground and the zero line, the resistance should be less than 10 ohms.



5. How to Use

5.1 How to use—basic

5.1.1 How to connect a USB cable

The following are details on how to connect the USB cable, and the precautions.



Attention Turn off the machine before connecting the USB cable or disconnecting it.

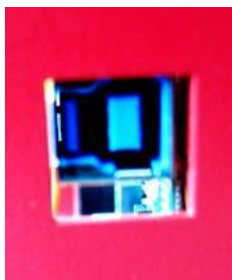

As shown in the figure, connect the computer and the machine with a USB cable.



Attention The computer's USB interface must be version 2.0 and above.

5.1.2 How to turn on the power cable

When connecting the power cable, connect the power cable to the socket on the following specifications.

- ✧ Voltage: AC 220V \pm 10%
- ✧ Frequency: 50 Hz \pm 1 Hz
- ✧ Power: 16 amps (3500 watts or more)



Attention Turn off the machine before connecting the power cable or disconnecting it

- 1) Connect the power cable as shown below:



- 2) The power supply is turned on and off by switching the position of the switch as shown below.



- Turn on the power supply: Push the switch up.
 - ◇ Please confirm that the ground wire is connected before starting up.
 - ◇ When the power is turned on for the first time (the USB cable is connected) The computer will display the new hardware. Follow the instructions below.
- Turn off the power supply: Push the switch down.
 - ◇ Make sure that the printer head is protected well before turning off the machine.

5.1.3 How to add ink

The method of adding ink for bottled ink and boxed ink is illustrated below.

Bottled ink:

Unscrew the bottled ink cover, remove the diaphragm with a blade, and then pour it into the ink tank.



Boxed ink:

Remove the ink bag from the box, and then cut a small mouth with a scissors in the corner, and then pour the ink into the ink tank according to the method of bottled ink.



Attention Before adding ink, please check the capacity of the boxed ink (usually 1000ML), the capacity of the ink tank is 1500ML. Try to make sure that every time you add ink, the boxed ink can be used up. Because boxed ink is not easy to be saved.

5.1.4 How to install media

Roll to roll

Please use special materials suitable for this machine. (Details: 5-1-6)



Attention

- ◇ The web is heavy, please be careful not to fall off to the feet.
- ◇ Before installing the web, be sure to check the height of the carriage.
- ◇ Please confirm the print side of the material.

- 1) Place the material on the dispensing support (not fixed).



- 2) Pass the material through the pole.

It can be replaced with empty fiber container if it is the lighter materials such as a bicycle commuter's allowance, in order not to affect the step.



- 3) Behind the machine, pull out the web 50-60CM

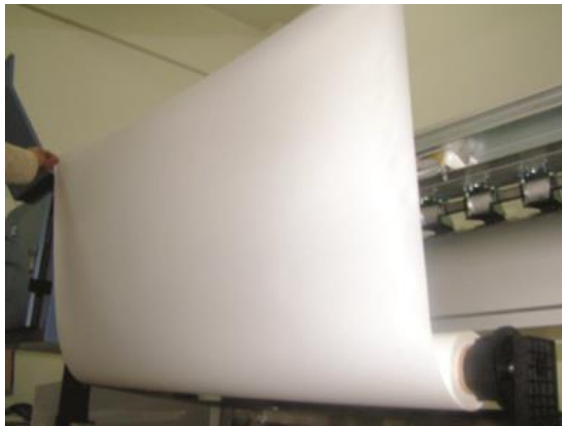

- 4) Pass material through the platform to reach the front of the machine in a consistent state.

5.1.5 The available media

The following describes the types of media that can be used and the methods of storage.

Available media: “roll to roll” and “flatbed”

◆ Available media sizes

Because of different model of Refretonic, the size of the media varies a lot. The following is the details.

	Size	UV3202R
Roll to roll	Maximum width	3200mm
	Maximum print width	3200mm
	Web size	Diameter below 250mm
	Web weight	60KG or less
	Paper tube diameter	2 inches or 3 inches



Attention

- Please use special materials

Please use the material for this machine. The Company shall not be liable for any

failure of the machine due to the use of other materials.

- The thickness of the medium
When installing different thickness of the material, be sure to adjust the height of the carriage, otherwise it may damage the carriage and the printer head.
- The expansion and contraction of the medium
When opening a packaged material, do not use it immediately. Due to temperature and humidity in the room, sometimes the material will be stretching. Please open for more than half an hour before use.
- Curled medium
Please do not use the media has been curled or deformed; otherwise it will scratch the printer head and then cause damage. When you need to keep the media curled, place the coating surface out.
- Other precautions
Do not place anything on the surface of the coating. When you take the media, you should wear cotton gloves. You should not touch the surface directly with your hand. The ink can't be printed on the coating touched by hand or other objects. Transparent media and black media on the back sometimes cannot be correctly detected (width).

5.1.6 How to use the platform to breathe



5.2 How to use—printing

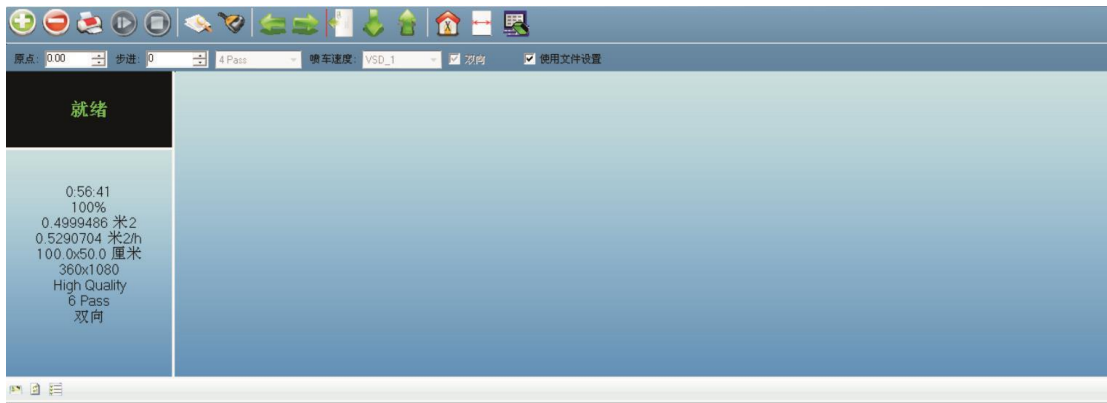

5.2.1 How to feed / take and set the print start position

◆ Feeding up system



◆ Taking up system



Set the print start position

There are two ways to set the print start position.

- 1) Set the print start position with the LCD control panel to bring the machine back to the standby screen. If it is not on the standby screen, press the left button



to exit all menus and return to the standby screen.

Press the button  to move the car to the print start position, and then press the

原点

button  .

- 2) Use the control software to set the print start position

On the right side of the beam of the machine there is a meter scale, according to the size corresponding to the material, filling the number in the software toolbar white side, the unit is mm.

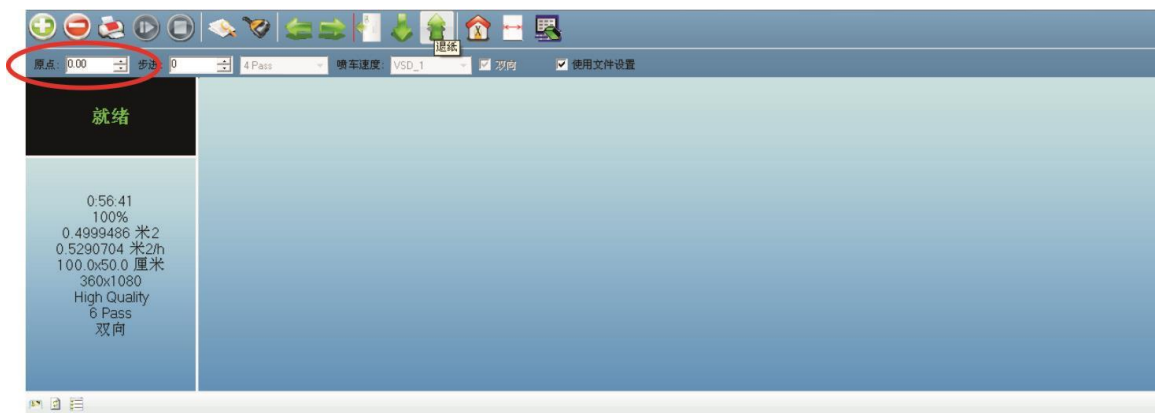

5.2.2 How to print the heads status test strip to check the print head

The printer head status test is to check all the hole is smooth, and the printer head is in the best condition.

There are two ways to print this test chart.

- 1) Print with the LCD control panel

Embedded menu adjustment steps of Ricoh Gen5 machine

LCD panel

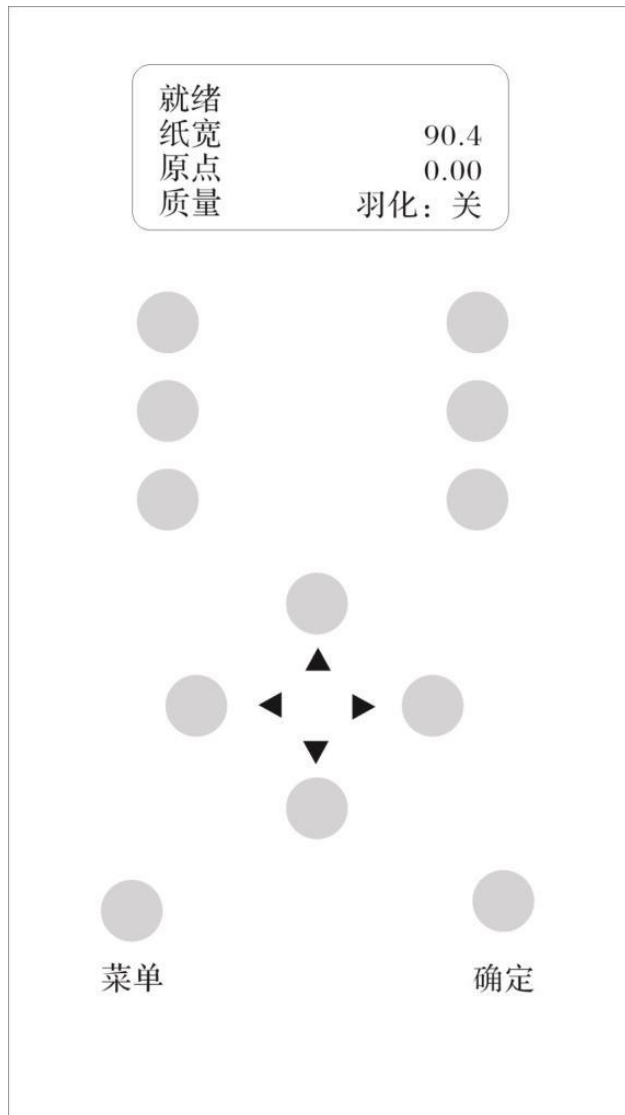

2) Print with the control software

Once the material and print start position are set well, click the test button on the toolbar and choose “printer head status”.

5.2.3 How to press ink

After installing the shower nozzle and inpouring ink, we can press ink though pressing the pressing ink button under the control panel. If you can't squeeze out the ink, please check if the trachea is leaking.

5.2.4 How to adjust the height of the carriage

In order to adapt to different thickness of the material, we need to adjust the height

of the car.

Attention: The height of the carriage can be adjusted 0-5cm, the recommended height is 1-2mm between the printer head and the material.

Automatic measurement

Move the carriage to the top of the material, and then select “automatically measure the thickness of the media”, when the measurement is completed, select “Save”.

Manual measurement

First measure the thickness of the material with a vernier caliper, and then input material thickness on Z-axis (the value needs to add the printing distance of 1-2mm)

5.2.5 How to start, pause and stop

◆ Start

- 1) Open the file you want to print

Start the software; click the Open button on the software toolbar to select the file you want to print.



You can also select the path where you want to print the file in the print job information field. And then in the part of the preview bar, clicking the right mouse button, select “Refresh” .

- 2) Set the print parameters

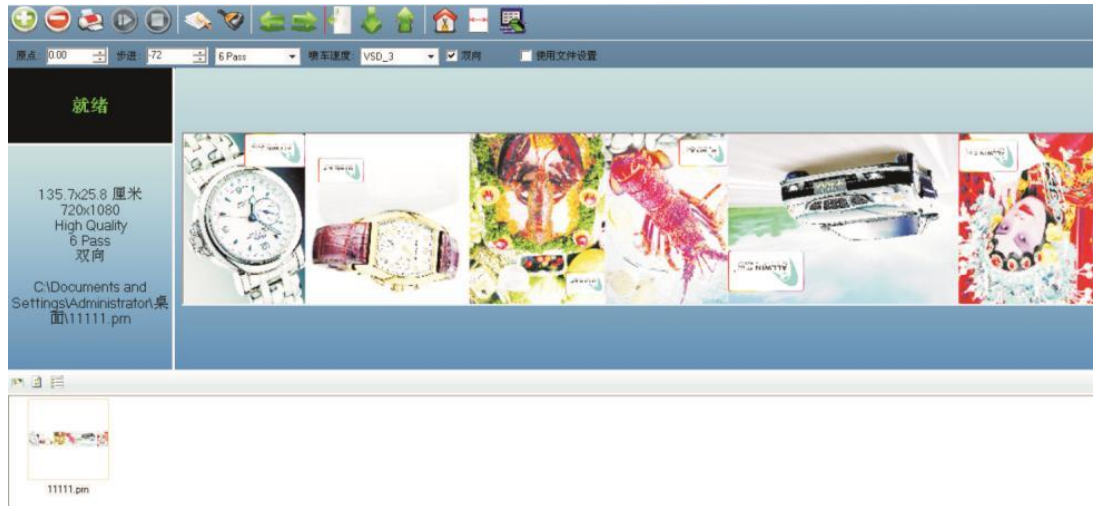

Set the print properties, in the software's real-time parameter settings bar to set the white edge, print speed, print mode (single and double direction) and whether color bars are needed.

3) Task property settings

Select the file you want to print in the preview bar of the print job information field, clicking the right mouse button and selecting “Print” on the pop-up menu. There will pop up the Task Properties dialog box.

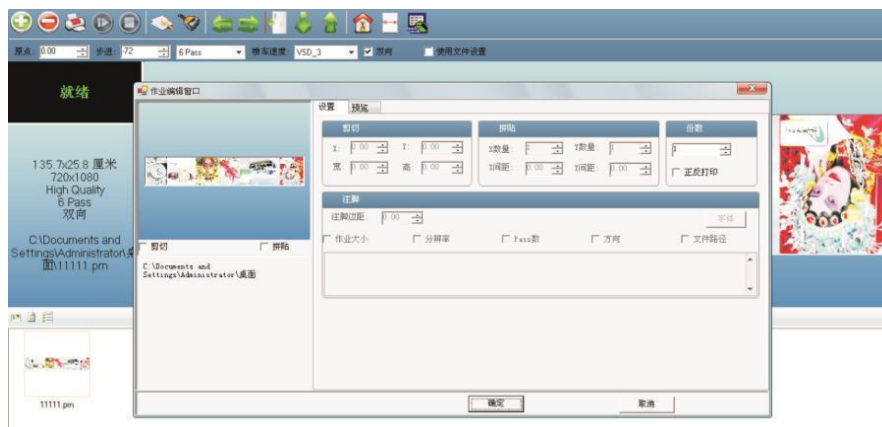

Set the task property well. The task property includes printing PASS, the number of copies, print area, print ink and other settings. Please refer to Section 6.2.6 for details.

4) Start printing

After confirming the task attributes, click “OK” to start printing.

◆ Pause

Pause printing can be achieved through the LCD control panel and control software.

LCD control panel

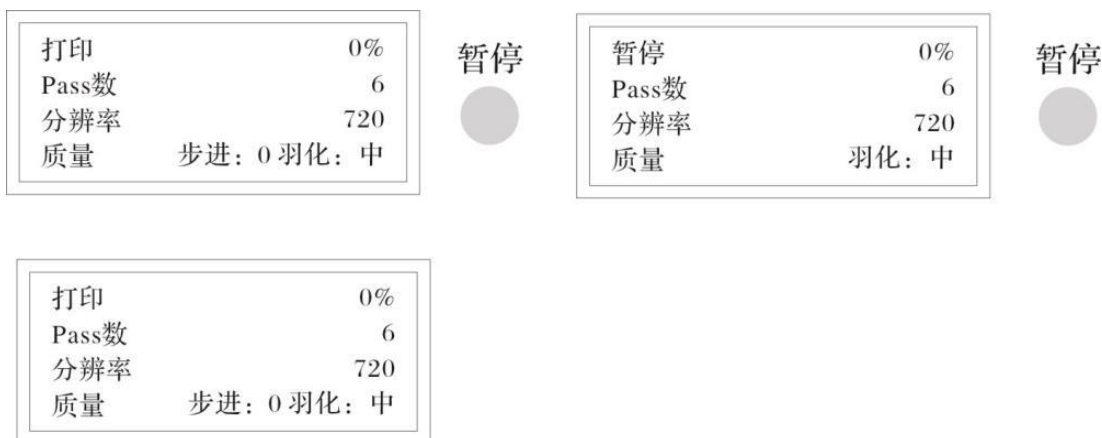

Press the Pause / Continue button once to pause the printing. And press the Pause / Continue button again to reset printing.

5.2.6 The distinction between print modes

The PASS and hourly production quantities and recommended print modes are described in detail below.

Available printing mode

Printing Accuracy	Pass	Speed	Output
720*600	6	High Accuracy	8.7 Square / h
720*600	4	High Speed	25.8 Square / h
720*1200	8	High Accuracy	6.3 Square / h
720*1200	8	High Speed	12.4 Square / h

5.2.7 How to take up the picture

- 1) When the picture arrives at the paper tube, stick the picture on the tube with three stickers (car stickers or PP adhesive).



Attention

If the torque is too small, it is easy to deviate when taking up the material.

If the torque is too large, it will affect the print quality.

5.2.8 How to maintain blow head

The Maintenance method of UV ink is different from the water-based ink machine and the eco solvent based ink machine, and the maintenance method will be described in detail below.

In the off state, we can pour cleaning liquid with non-woven fabrics and paste on the surface of the nozzle for keeping it moist, then cover the nose with a piece of black cloth.



Attention

The maintenance method is limited to turn off the machine before you are off duty every day. If you do not use the machine for a long time (more than 10 days), you need to clean the entire ink supply system.

5.3 How to use-- LCD control panel

5.3.1 The layout of the control panel

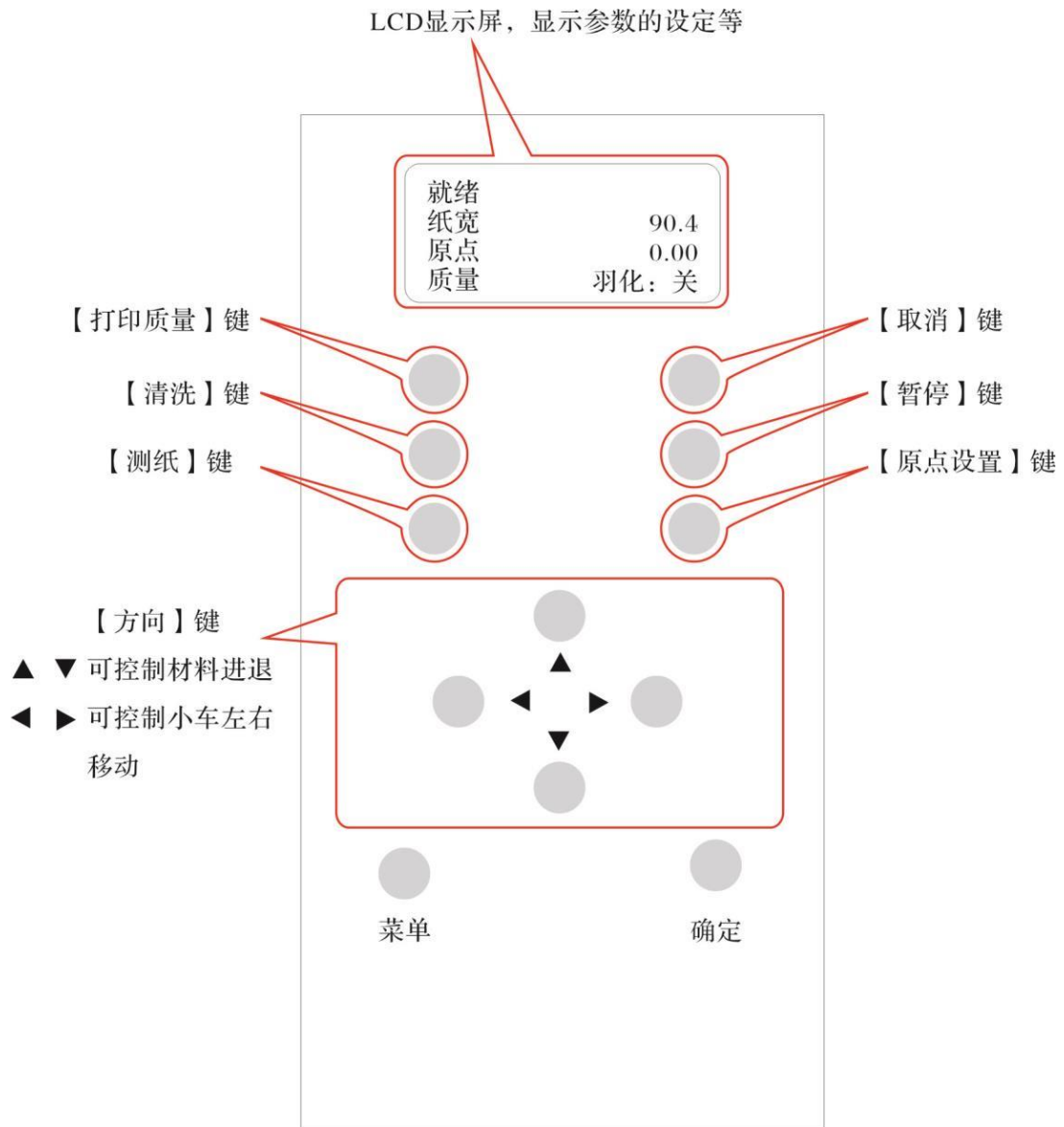

5.3.2 Instructions for the use of the buttons

◀ ● ● ▶ Press this button for a long time to control the movement of the carriage. When the carriage comes to the destination, release the button, and the carriage will stop immediately. In the case of menu, it indicates returning and entering the menu.

● ▲ ● ▼ The material is back and forward. In the case of menu, you can choose the upper and lower menu.

暂停



When a break occurs during printing, you can press the button once to pause the print and then clean the printer head. After cleaning the printer head, press the button again to resume printing.

打印	0%
Pass数	6
分辨率	720
质量	步进: 0 羽化: 中

暂停



暂停	0%
Pass数	6
分辨率	720
质量	羽化: 中

清洗



暂停



打印	0%
Pass数	6
分辨率	720
质量	步进: 0 羽化: 中

取消



Cancel the current print, press “Cancel” once during printing, cancel the current print and return to the standby menu.

打印	0%
Pass数	6
分辨率	720
质量	步进: 0 羽化: 中

取消



就绪	
纸宽	360.00
原点	55
质量	羽化: 中

确定



It is to determine and save changes in the menu.

菜单



Menu settings. Some of the machine's parameter settings are the same as those in the software. And they are real-time. The last parameter setting is the exact parameter of machine settings and software settings.

就绪	
纸宽	360.00
原点	55
质量	羽化：中

菜单



喷嘴检查	▶
喷头清洗	▶
校准	▶
纸张类型	▶

确定



VSD1	
VSD2	
VSD3	
VSD4	

6. Instructions for Using the Software

6.1 The installation of the software

Find PrintExp print control software CD in the machine box, and then put it into the computer's drive, open the PrintExp installation disk, double-click PrintExp_Setup.exe, the following picture appears.

名称	修改日期	类型	大小
app.ico	2008/6/20 18:54	图标	15 KB
Setup.exe	2003/3/19 13:03	应用程序	108 KB
Setup.ini	2012/4/9 15:27	配置设置	1 KB
SetupPrinterManager.msi	2012/4/9 15:27	Windows Install...	4,892 KB
Vender.xml	2012/4/10 13:10	XML 文档	1 KB

Double-click the "SetupPrinterManager.msi"



Click "Next"

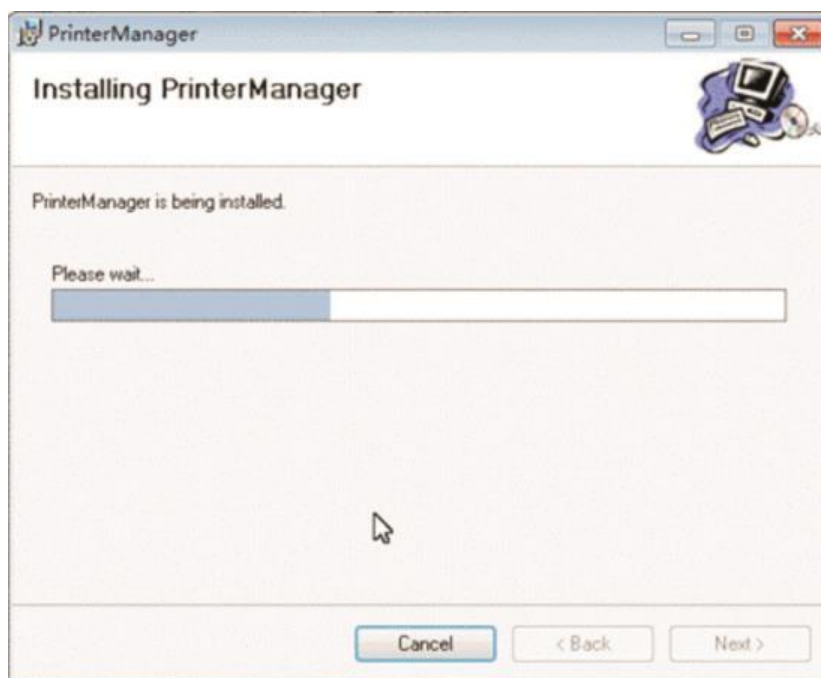

Select the path where the software is installed, default C \ Program Files \ PrintManager disk. You can "Browse" to select the directory you want to install, and then click "Next".

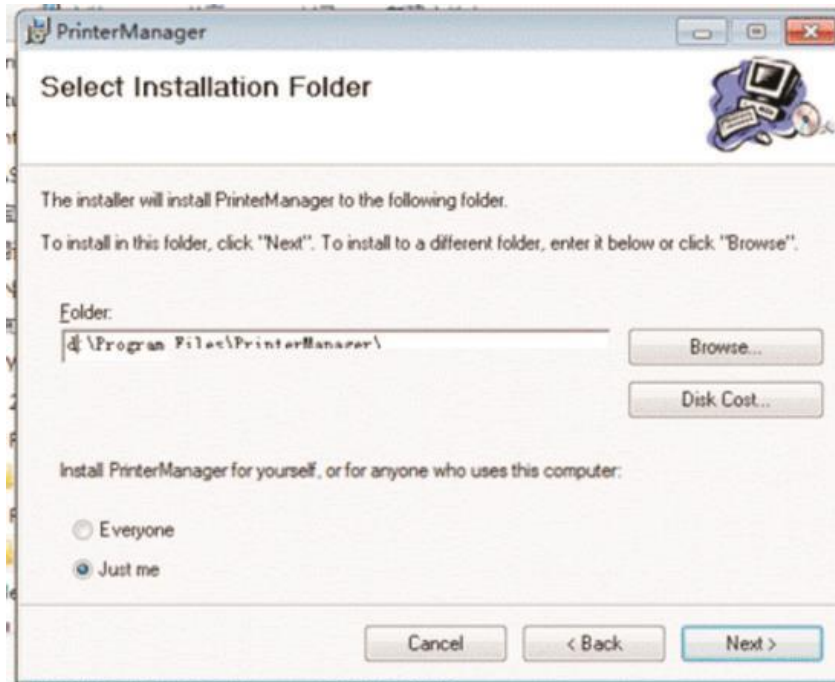

Attention

It is recommended to use the default path C \ Program Files \ PrinterManager, if you choose other paths it is easily deleted and there will be some potential instability.

Click "Done"

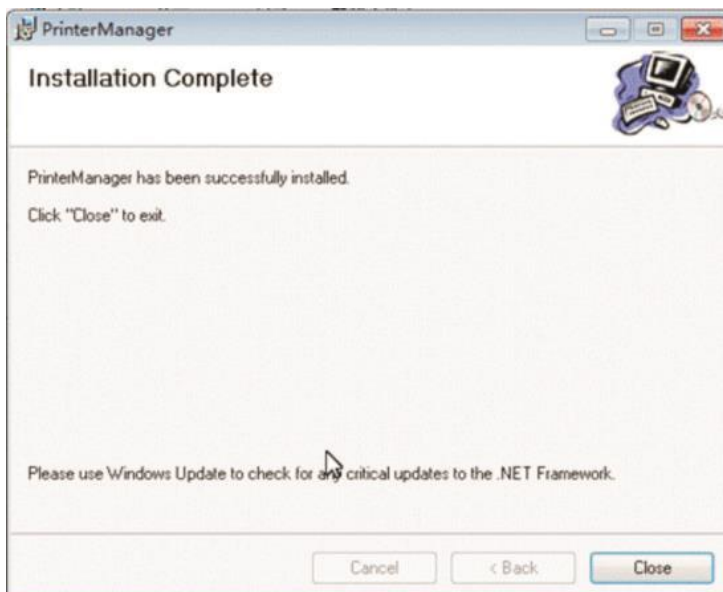

6.2 Interface description



Double-click  on the desktop or find PrintManager click in the "Start / Program", the Initial Print Configuration window for the PrintManager print control software will appear. As shown below:



Attention

Please select the correct configuration file, and if you select the wrong configuration file, it will not print properly.

6.2.1 Toolbar

From left to right are:

- 1) Open: Select to open the RIP image format in the specified directory. If the RIP image file is stored in the E root directory, open to the E root directory and select the file.



Attention Don't save the RIP file in the C drive or system disk directory. C disk is generally a system disk. If the disk space is not enough, it will seriously affect the speed of IP and there may be errors.

- 2) Delete: Delete the printed file.
- 3) Print: Print the current job, confirm the file, and click this button to start printing.
- 4) Pause: Pause the current print job during printing. When you click the pause button with the mouse, the button changes to the "Continue" button, and then click "Continue" button, it will resume to the paused print. This function is the same as the pause button function on the LCD control panel.
- 5) Stop: Cancel the current job. When the job is canceled, printing cannot be resumed
- 6) Test: Print the head test state diagram.

Print head status: Click this button to print the head status test. This function is the same as the test button on the LCD control panel. Check whether the current print head is blocked, if you find the lost needles, please clean it and then print the head state diagram to confirm, until the holes are all out. Click the "print head status", as shown below.



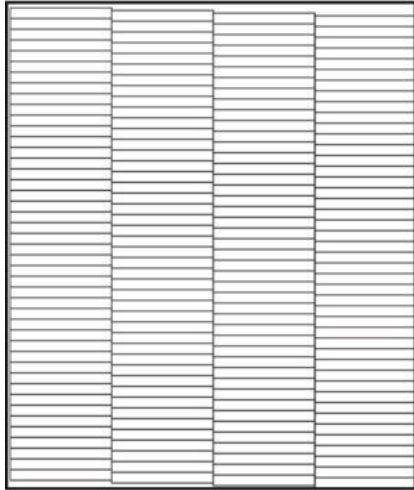

▲Ok, 可以正常打印

It is ok to print.



Attention

If there are lost needles, click the cleaning button on the toolbar to clean the print head. After cleaning, continue to print test, and check the needle is complete. If there are still lost needles after cleaning several times, please contact the local distributors.

- 7) Clean: Clean the print head, click this button the ink pump will start pumping the print head.
- 8) Flash: Click this button will toggle the status bar to flash.
- 9) Left shift: The carriage moves to the left, which is the same as the left button on the LCD control panel.
- 10) Right shift: The carriage moves to the right, which is the same as the left button on the LCD control panel.
- 11) Set the origin: Set the print start position.
- 12) Feeding up: The print carrier advances, which is the same as the down button on the LCD control panel
- 13) Taking up: The print carrier backs, which is the same as the down button on the LCD control panel.
- 14) The carriage goes up: This feature is not yet available.
- 15) The carriage goes down: This feature is not yet available.



▲若有丢针的情况，请清洗喷头，以免影响打印质量

Please clean the print head.

- 16) Reset: The carriage comes back to the origin.
- 17) The height of the carriage comes back to the origin: This feature is not yet available.
- 18) Set: The setting options of Software function.

6.2.2 Quick exit button

The Quick Exit button is located in the upper left corner of the interface and you can double-click the button to quickly exit and close the software.

6.2.3 Print parameter real-time settings bar

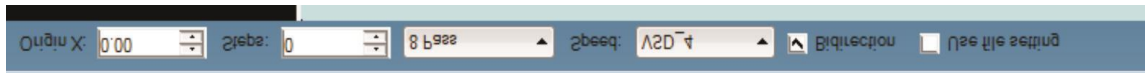

This parameter can be set in real time, that is, in the process of printing this parameter can be set in real time.

From left to right are:

- 1) White edge: the print start position of the print head
- 2) Stepping: Fine stepping in the process of printing
- 3) Pass: Choose the Pass number
- 4) Print speed: The print speed of the carriage, (VSD1, VSD2, VSD3, VSD4) are optional.
- 5) Print direction: The print direction of the carriage, (One-way, two-way) is optional.
- 6) File settings: If checked, it will print based on RIP parameters.

6.2.4 Print job information bar

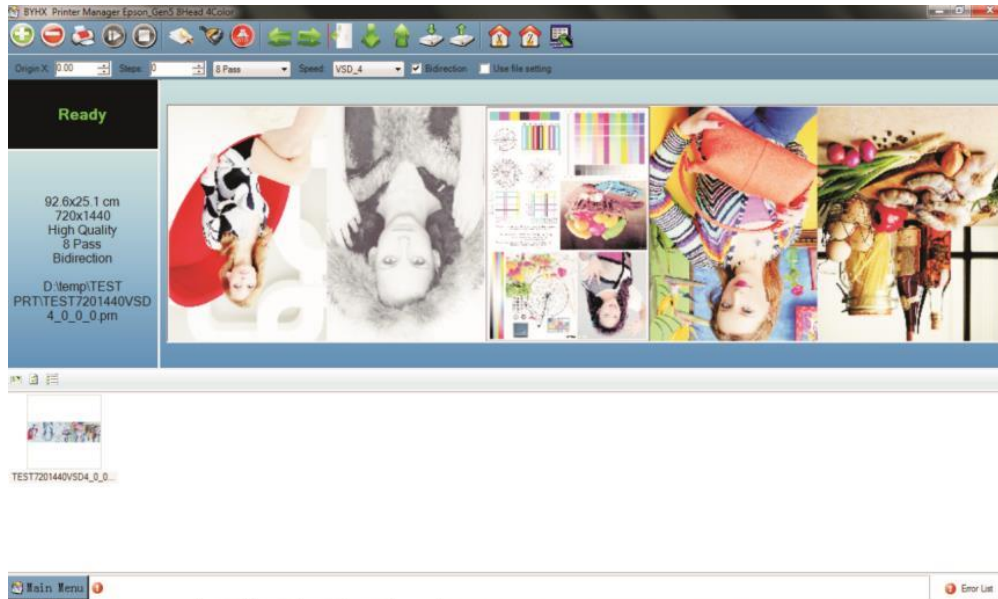

Upper right: preview bar. You can right click in the blank area to select “Refresh” , and it will refresh the directory of the file preview.

Upper left: Display information about the print job

Lower left: The queue box of print task

6.2.5 Print job

In the print job information bar, select the job you want to print and click the right mouse button and then there will pop up the file operation options. As shown below:



Refresh: Refresh the RIP file preview diagram

Re-preview: Re-preview the file

Re-preview all: Re-preview all the files

Delete: Delete the preview of the file, and then you can refresh the preview.

Delete Files: Delete the source file, then you need to re-RIP file.

Add to the print queue: Add the jobs that need to be printed to the queue, which is only added to the queue and is not printed immediately.

After adding a job to the queue, you can select the job you want to print in the Print Job Queue. Right-click to perform the task property (change the print PASS, speed, etc.) / delete task / print job (print immediately).

Print: Print the job directly. (After this step is executed, the Print Job Properties dialog box appears.) Here you can select the property of the print job.

PASS mode: select the number of print coverage

Multiple print settings: You can set up multiple copies of a job.

The number of horizontal frames: Multiple prints, select the horizontal side by side multiple prints

Horizontal interval: Interval settings for multiple horizontal prints.

The number of vertical frames: Multiple prints, select the vertical multiple prints

Vertical interval: Interval settings for multiple vertical prints

6.3 Parameter setting

The parameter settings are mainly composed of material settings, print settings and offset correction, and basic parameter settings. The settings and functions of each parameter are described in detail below.

6.3.1 Print setting

There will be the settings during the printing and standby. As shown below:



- 1) Print mode: high speed and high precision are available.
- 2) Color bar

The distance of the color bar: the edge of the image

The width of the color bar: set the width of the color bar

The position of the color bar: the location of the printed image (left, right and both sides) is optional.

6.3.2 Personality setting

There will be personality setting. As shown below.

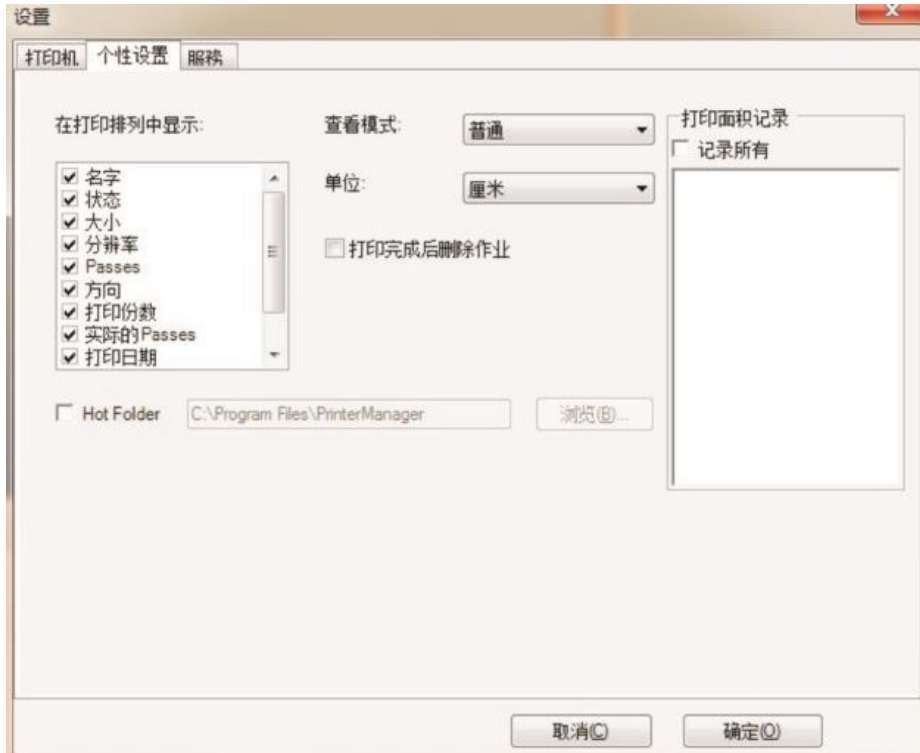

- 1) View mode: ordinary and widescreen
- 2) Unit: select the desired unit

6.3.3 Offset correction

There will be the color calibration, two-way calibration and stepping calibration of the print head. For details, please read the next section.

6.4 Print head calibration

There will be the details for the print head calibration. There are two aspects of the adjustment of the machine. The first one is mechanical adjustment. The second one is software fine-tuning.

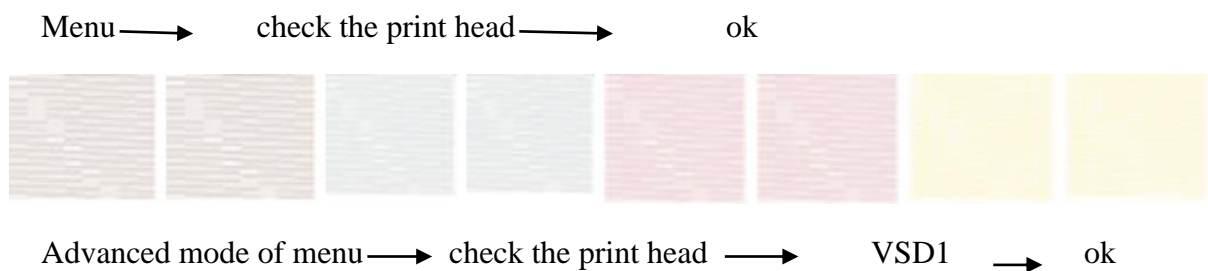

Print 4 different VSD mode test diagram of the print head. Because of the different variable point, the color of the diagram is different.

If there are discontinuity and vacancy, which indicates the print head is blocked. And you need to press ink until the ink jet is in the best condition. It is good for observing the print test and improving the print quality of the job.

6.4.1 Check the dislocation of the hole

Attention

Before calibration, print and check the condition of the print head. If the condition is bad, please clean the print head until it is in the best condition.

Mechanical adjustment mainly includes checking the dislocation of the hole and the incline.

1) Mechanical adjustment

You can adjust the print head based on the fixed structure. And finally, the print head is parallel to the flatbed.

Check the dislocation of the hole:

Advanced mode of the menu → calibration → check the dislocation of the hole → ok



As shown above, observe the printed test diagram with 50-100 times magnifier. Black is the benchmark, for the position relationship between black and other color, for the hole on the same horizontal line with “K” and the hole on the second row with “K”. And it lists the relative position of the two rows of hole in the same color. Because the color of “K” and “Y” is relatively far, if the dislocation occurs, the performance is the most obvious. You should observe “K” and “Y” firstly. When “K” and “Y” are three lines, they should overlap each other. When “K” is three lines, “Y” is two lines; they should be crossed into each other.

Attention

It is the opposite of reality with the magnifier. When they are all three lines, they should overlap with “K”. The place where the color is two lines should be printed in

the middle of “K”. As shown above “normal”, otherwise, you should adjust the physical position of the print head until it can print normally. Sometimes, there will be something wrong with the print head, after checking the dislocation of the hole, the outcome of the printing is not ideal. The three lines can overlap with “K”, but the other row of hole can’t be printed in the middle of “K”. When there are two print heads of the machine, there will be two test strips. Adjust the two print head at the same time, and correct the print head by adjusting the screws shown on the diagram.

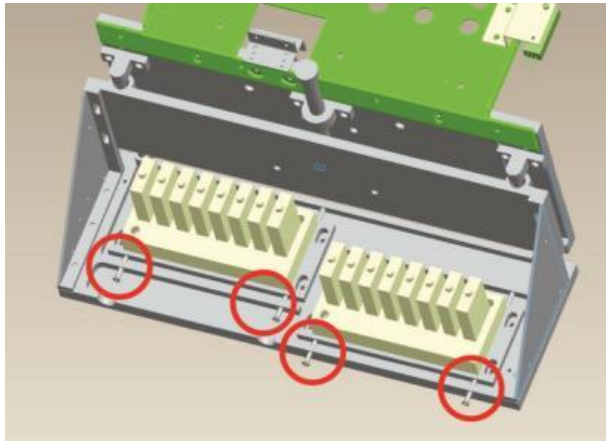

6.4.2 Check the incline

Check the incline:

Advanced mode of the menu → calibration → check the incline → enter

After adjusting the level of the print head, we can't ensure the surface is horizontal. There may be the inside is high but the outside is low or the inside is low and the outside is high. Then we should check the incline to confirm the condition of the print head.

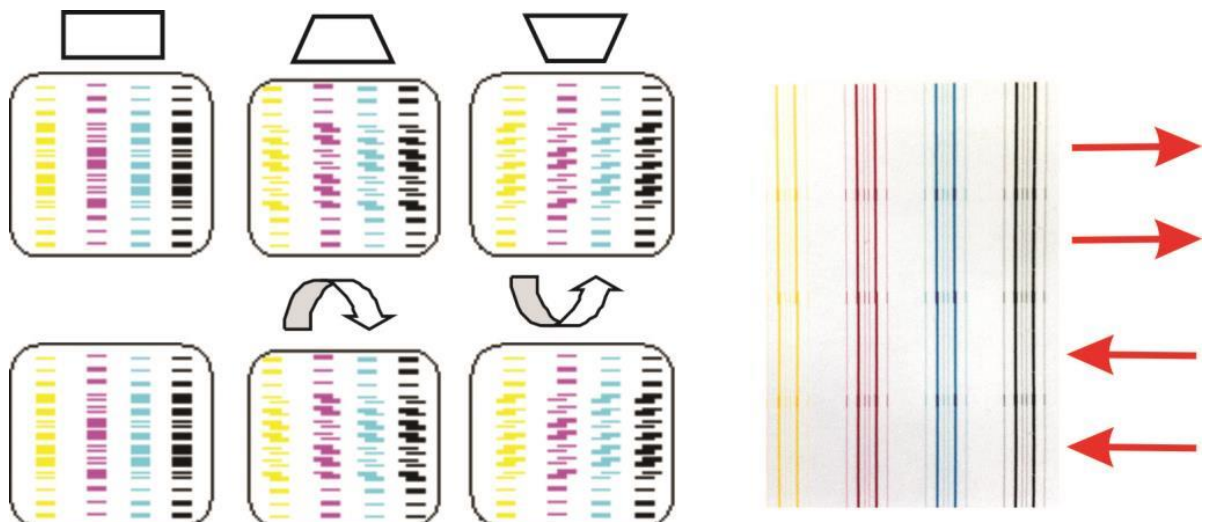



Attention

The test diagram is printed twice from right to left and then twice from left to right. If the wide line is not clear, you can observe the thin line on both sides. If the inside of the print head is high and the outside is low, they will be the middle one. On the contrary, they will be the third one. When the result is the same with two directions, you should check whether the direction is vertical with the rail. And maybe the platform is not flat. You can print the test strips in other place and then check the result.

If there is a lot of dislocation in the overlapping place, without observing, it is the error of bidirectional adjustment.

For two print heads, the adjustment is similar. In general, the second print head prints worse than the first print head. Because the second print head is far from the rail. If you find the print results of the two print heads are the opposite, you need to check the installation of the print head or the baseboard. Sometimes because of mechanical processing, it is difficult to adjust to the consistent printing of two directions. But you should ensure at least one direction is ok.

6.4.3 Check the vertical spacing of the print head

Till now, the physical adjustment is over. But for the machine with two print heads, you need to adjust the vertical spacing of the two print heads.

Advanced mode of menu → calibration → check the vertical spacing of the print head → enter

As shown below.

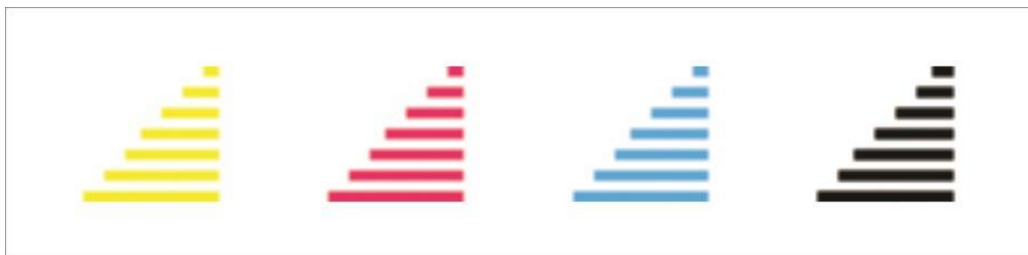



Attention

The upper triangle is printed by the first print head. The following trapezoid is printed by the second print head. The distance between the line printed by the lowest of the first print head and the line printed by the top of the second print head is the same as the printing space of the neighboring two holes. That's to say, when ignoring the more places of the right side of the trapezoid, you can't distinguish the line, which proves that it is ok and you do not need to adjust.

In general, after checking the dislocation of the hole and the first two steps of checking the incline, the two print head is horizontal. You just need to translate the second print head to close to the first one. When translating the second print head, there may be inclining. You need to check the dislocation of the hole again, and adjust again.

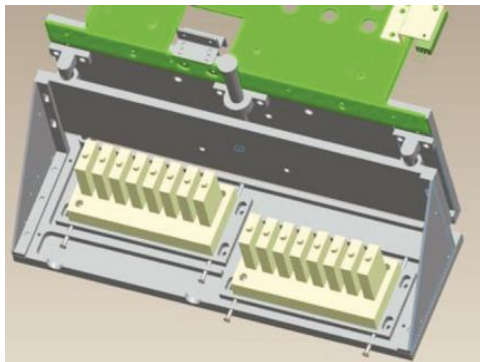

6.4.4 Check the stepping

Software trimming includes stepping, bi-direction, left justified, right justified and so on.

Stepping adjustment:

Normal mode: Menu → calibration → medium → print

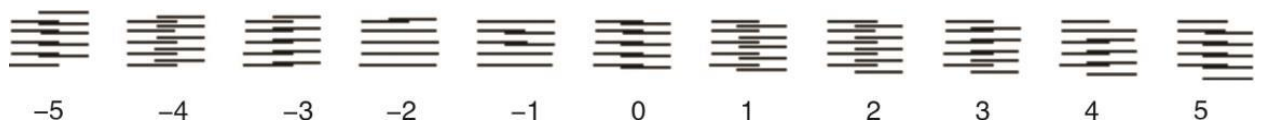

It only prints one line, and it is a simple adjustment. The default stepping is 4PASS.

It is similar to the 1PASS to adjust the value of stepping. Every test diagram has its own value, selecting the best one, and then plus the corresponding value to the default value. Finally, input the value.

Advanced mode:

Advanced mode of menu → calibration → media → PASS → print

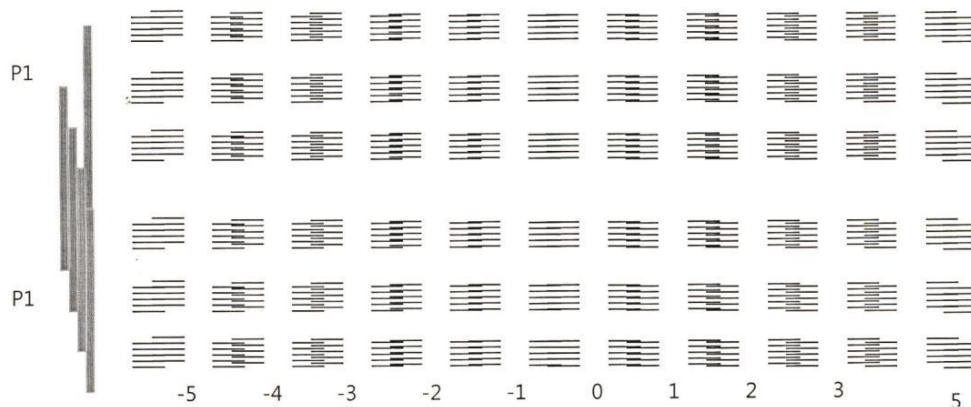

Advanced mode not only provides the media type, but also provides a different PASS number selection. Firstly, adjust the PASS, and its stepping value will correspond to the other PASS. And then adjust 3 PASS, 6 PASS, 8 PASS and other PASS of the same media. And the stepping of other PASS is adjusted on the basis of 4 PASS.

There is different stepping value with different media. When printing, be sure to confirm that the media you are using is consistent with the machine's default media.



Attention

In this mode, the machine will print 100 consecutive cycles. 4 PASS prints 3 lines. The first line is printed by the first and the second PASS. The second line is printed by the first and third PASS. The third line is printed by the first and the fourth PASS. If there is an error in stepping, the error of the third line will be the largest one. Because of 100 cycles, the printing is long. It is easy to find the problem of the stepping. And also you can check the accuracy of feeding / taking up system, and whether there will be cyclical changes. 6 PASS prints 5 lines. 8 PASS prints 7 lines.

The test diagram prints “K” and “M”. If there is no error of the physical position of the print head, the stepping direction should be consistent. In particular, you need to observe whether the left vertical bar is complete and continuous. If the print head is skewed, there will be a gap of the left side of the vertical bar and it won’t form a complete color block.

You can cancel the print by pressing “Cancel” during printing. If it is difficult to determine whether the “0” is completely aligned, you can observe which side is much wrong, then the other side is the best one. You can also test in different parts of the media in order to check the mechanical accuracy.



Attention:

If there are many differences between the stepping value with the actual printing, you can look at the effect of the first line. Maybe you need to reduce or increase the value. The maximum amount of each change allowed is 50%. Until the “0” of the first line is aligned, then observe the “0” of the third line and adjust. The stepping of one print head is the half of two print heads.

6.4.5 Two-way adjustment

Advanced mode of menu → calibration → resolution (360/720) → VSD (1, 2, 3, 4)
 → Two-way → print

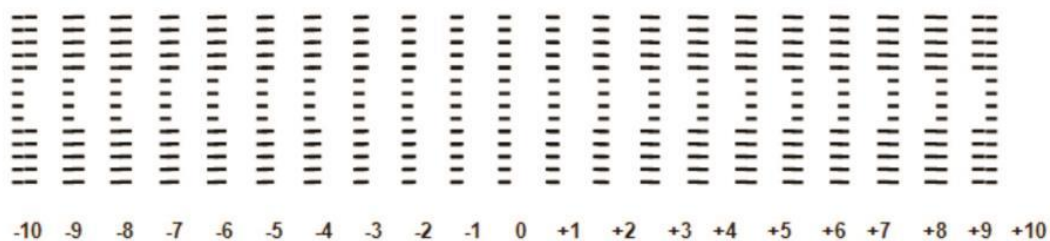

Observe the test diagram, plus the value whose position is relatively neat to the default value and then input it to the menu. Different resolution and different VSD correspond to different adjustment parameters. Therefore, you need to adjust each mode separately. 4 VSD modes are for 360dpi, and 4 VSD modes are for 720dpi. If there are high and low of the print head, you need to adjust separately. If not, the

menu which shows the high, just need to adjust the high. If the display is low, only need to adjust the low value.

Left justified

Advanced mode of menu → calibration → resolution (360/720) → VSD (1, 2, 3, 4)

→ Left justified → print

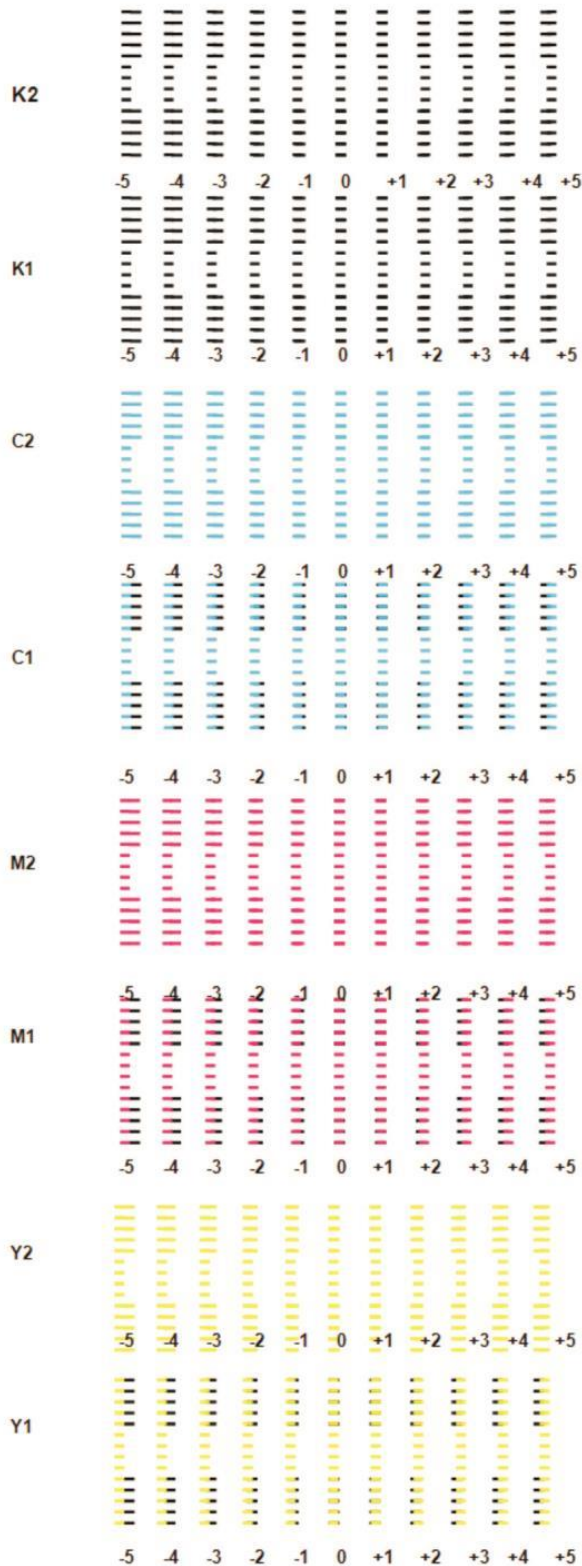

Observe the combination of different colors for each row, plus the value of the best position to the default value of the menu, and then input the new value to the menu. In this diagram, 2 is the relative position of two rows of holes in the same color. Adjust the same color of the two rows of holes to the left to print, after alignment to establish its own benchmark. 1 is based on the first row of K for K1. All other colors are aligned with K1. If the left row of hole is 1, the right row of hole is 2, the figure above is: K1K2, K1K1, C1C2, C1K1, M1M2, M1K1, Y1Y2, Y1K1.



Attention:

As the four colors on the same print head, the 8-hole position is relatively fixed. “0” in this test diagram is the most aligned on the basis of physical location. If there are many errors, which indicates that physical adjustment hasn’t done well. You need to check the dislocation and the incline of the print head again, and adjust again. When there are two print heads, the principle of adjustment is similar. But the test diagram will be printed twice. The hole on the left row of the first print head is the benchmark (H1K1, H1C1, H1M1, and H1Y1). All other positions of the same color are aligned to this benchmark. Then, these benchmarks (H1C1, H1M1, H1Y1) are aligned to H1K1. H1 is the print head facing to the left side of the machine, is the first print head. And the right one is the second print head. In the test diagram, H1K2, H2K2, H1K1, H2K1, H1C2, H2C2, H1C1, H2C1, H1M2, H2M2, H1M1, H2M1, H1Y2, H2Y2, H1Y1 and H2Y1.

H1K2 is a combination of H1K1 and H1K2, and is the result of the first print head’s left and right row of hole of K.

H2M2 is a combination of H1M1 and H2M2, and is the result of the first print head’s left row of hole of M and the second print head’s right row of hole of M.

Right justified

Advanced of menu → calibration → resolution (360/720) → VSD (1, 2, 3, 4)

→ Right justified → print

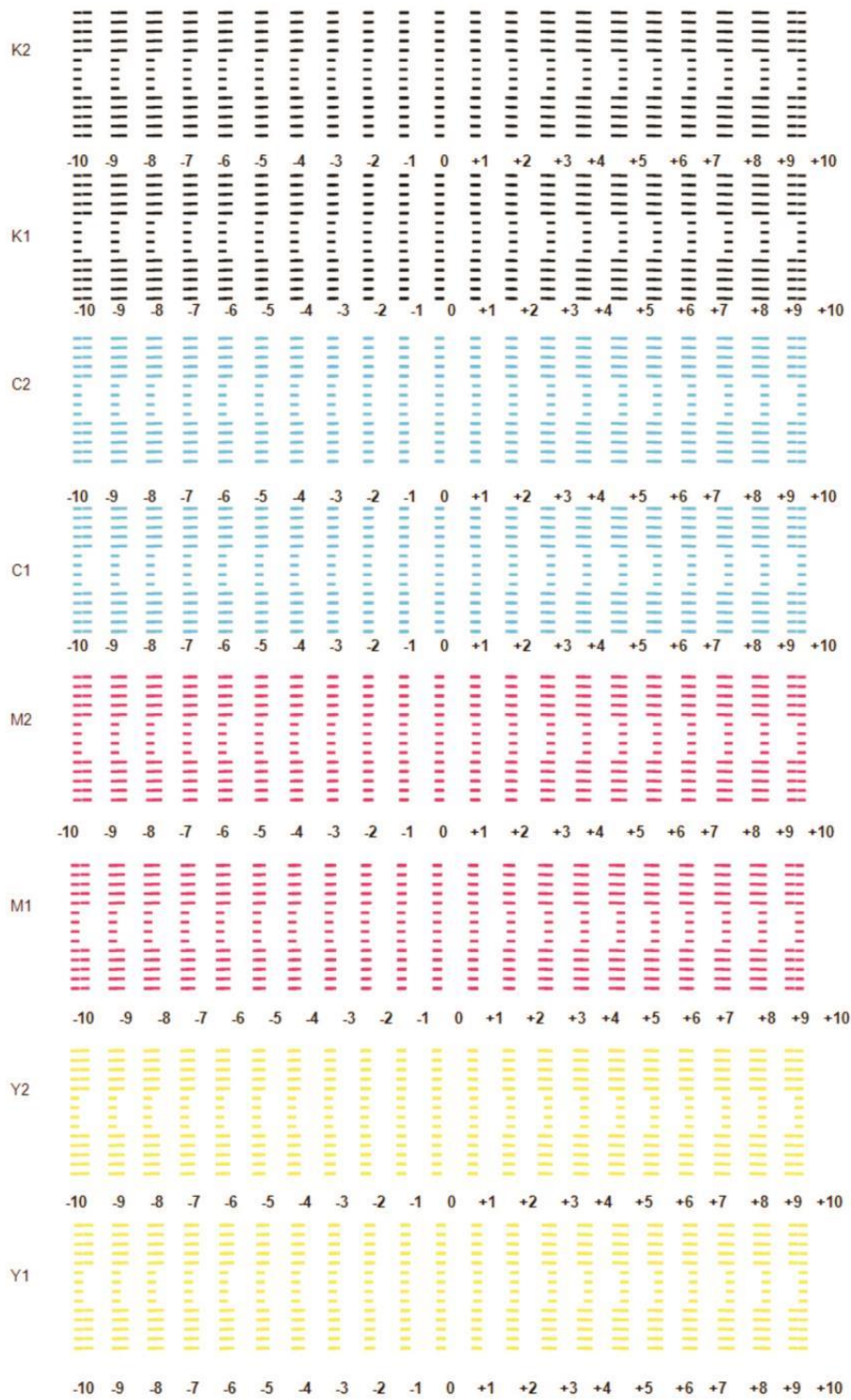

In the above diagram, “1” is the result (K1, C1, M1, Y1) of the left row of hole prints leftward and rightward, and it is two-way. “2” is the result of the left row of hole prints leftward and rightward.

When there are two print heads, it is based on H1K1, H1C1, H1M1 and H1Y1. The other hole of same color of two print heads is aligned with its benchmark. In the diagram, H1K2, H2K2, H1K1, H2K1, H1C2, H2C2, H1C1, H2C1, H1M2, H2M2, H1M1, H2M1, H1Y2, H2Y2, H1Y1 and H2Y1.

H1K2 is the result that H1K1 prints leftward and H1K2 prints rightward. That is the left and right hole of “K” of the first print head.

H2M2 is the result that H1M1 prints leftward and H2M2 prints rightward. That is the left column hole of the first print head and the right column hole of the second print head.

There are two-level benchmark of left and right justified. The first benchmark is the color itself. The second benchmark is “K”. Therefore, Not only adjust the color between each other, but also adjust the mutual position of the same color. Especially the same color of two print heads, it has improved the quality of printing the pure color blocks.

If you focus more on quality, VSD1 and VSD2 are seldom used. Therefore, the mode of 360dpi and 720dpi won't be adjusted.

7. Check the Defect (Blockage) of the Print Head

The following is about how to check the defect (blockage) of the print head.

1. Load media
2. Determine the print start position (white edge)
3. In the standby interface, press “Menu” and “OK” to print

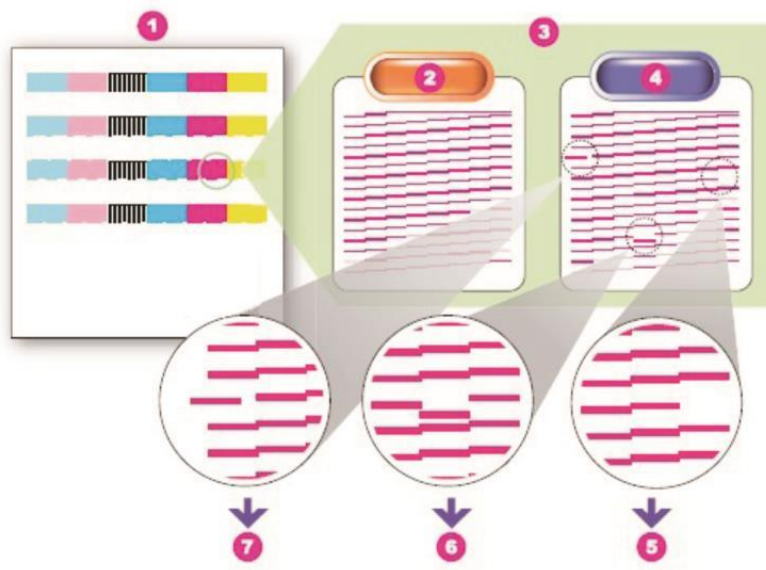

- i. The print head condition diagram
 - ii. Complete condition of the print head
 - iii. The diagram of the enlarged red hole
 - iv. The condition of defect (blockage)
 - v. Completely blocked
 - vi. Inclined
 - vii. Badly inclined
4. (Perform this step if the print head is defective.) In the standby interface, we can press the pressing ink button.



Attention:

Save the test strip diagram for inspection in time for the local distributors. If it is the uv ink for the machine, The print head surface is easy to dry. If there are still problems after the above steps, please contact the local distributors and solve the problem promptly. Otherwise, the print head will be blocked permanently.

Replace the print head

If you need to replace the print head, please contact the local distributors.

8. Refretonic Customer Service

As a strategic support partner, we will help you to work smoothly, which is our responsibility.

Refretonic customer service is comprehensive and professional. Our company has the feedback department in order to timely understand your suggestions and needs. Then, our service will be more professional and timely. Our service includes test and installation, the warranty upgrade, maintenance and replace, phone and web support, software update and self-maintenance. Please visit our website or call 021-54320723 to after-sale service department.

What you should do before calling:

- ◆ Please refer to the “common problems and solutions”
- ◆ Check the documentation for this machine
- ◆ If you have installed the third-party software drivers and RIP, please refer to its documentation.
- ◆ If the problem may be related to the application software, please contact the software supplier first.
- ◆ If you need to call the local distributors, please give us the following information:
 - The mode of the machine and the factory number (from the label)
 - If the LCD control panel shows the error code, note the code. And please refer to “Error Code Instructions”.
 - The computer you use.
 - Any special equipment and software you use (for example, antivirus software, restore software, mediator or special software drivers)
 - The cable you use and where you buy it
 - The type of interface (USB or Internet)